

VIVID S 270 DYNAMIC WHITE

Table of Contents

| | | | |
|--------------------------|-----|-------------------|-------|
| Specifications | 2-4 | Mounting Hardware | 8-9 |
| Technical Specifications | 2 | Standard | 8 |
| Physical Specifications | 3 | Plastic | 8 |
| | | Spring Clip | 9 |
| Part Number Naming | 3 | Flexible | 9 |
| Connectors | 4-9 | Packaging | 10 |
| Seamless | 4 | Testing | 10-14 |
| Submersible Seamless | 5 | Photometric Data | 10 |
| Snap | 6 | Certifications | 11 |
| Barrel | 7 | Fixture Testing | 11 |
| | | Charts | 12-14 |



For More Information

Toll Free: 1 (888) 580-6366

Or Visit www.GLLS.com/contact-us/

Technical Specifications

Light Dimension 0.45 x 1.14in (11.5x29mm)

| Output | | W/WW |
|-----------------------|---|------|
| LED Light | Epistar or Nichia SMD LED Chip | |
| Max Run Length* | | |
| Single Feed | 32.81ft (10m) | |
| Double Feed | 65.62ft (20m) | |
| Light Surface | Round profile 270° | |
| Lumen Maintenance | 70,000 Hours L70 @ 25°C : 90,000 L50 @ 25°C 50,000 Hours L70 @ 50°C : 70,000 Hours L50 @ 50°C | |
| Electrical | | |
| Input Voltage | 24V DC | |
| Power Consumption | 3.66W/ft (12W/m) | |
| Physical | | |
| LED Count | 44 LEDs/ft (144 LEDs/m) | |
| LED Spacing | 0.55in (13.89mm) | |
| Cutting Unit Length | 3.28in (83.3mm) (12 LEDs) | |
| Thermal Management | Free air convection | |
| Fixture Connections | End, side & bottom lead wires | |
| Minimum Bend Diameter | 4.72in (120mm) (Side Bending) | |
| Temperature Ranges | | |
| Installation | 32°F to 140°F (0°C to 60°C) | |
| Operating | -13°F to 140°F (-25°C to 60°C) | |
| Humidity | 0-95% non condensing | |
| Dependability | | |
| Warranty | 5 Year Warranty | |
| Safety | | |
| Certification | Tested to UL & CSA by Underwriters Laboratory for use in USA and Canada, complies with California Title 24 Requirements, Lighting Facts. Exceeds ANSI C78.377A, CE & RoHS Compliant. | |
| IP Rating | IP68 with appropriately rated accessories | |

*Max Run Length: Unless otherwise stated, snap and seamless run lengths are the same.

Available Colors

| Color | CCT Wavelength |
|-------|----------------|
| WW | 2460 ± 120K |
| W | 5029 ± 283K |
| W+WW | 3465 ± 245K |

Lumen Count

| Color | Per Foot | Per Meter | Power |
|-------|----------|-----------|------------------|
| WW | >39.62lm | >130lm | N/A |
| W | >39.62lm | >130lm | N/A |
| W+WW | >79.25lm | >260lm | 3.66W/ft (12W/m) |

*Color Jackets:

For standard or custom color jacket options, contact your Account Manager. Min. order quantity of 656ft (200m).

Physical Specifications



Light Profile

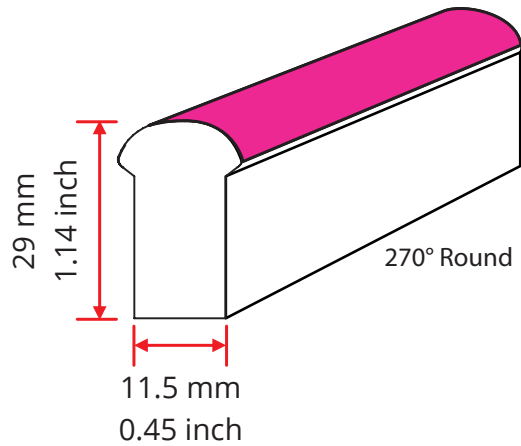

Bending Direction

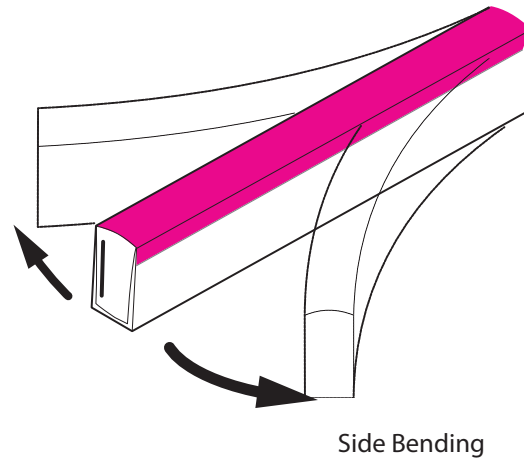

Minimum Bending Diameter

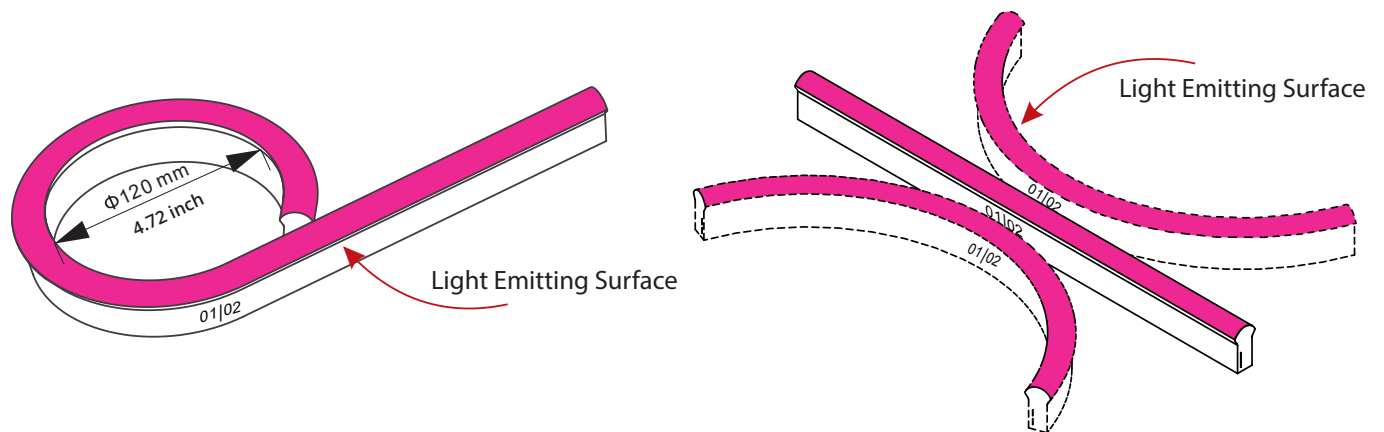

Part Number Naming Convention

NF-11D-1-01-3W-X-DWH-24DV



For full part number naming rules, please refer to the document on www.glls.com/support/documentation/

Connectors

Seamless Connectors

IP67: Rated for wet locations, not submersion.
Factory Assembly only.

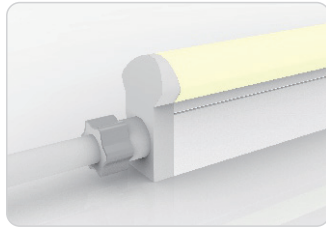

Seamless End Exit

NA-11D-1-01-3W-SE-0-EN-XXX-S

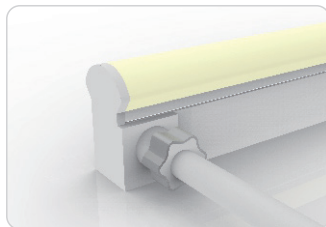
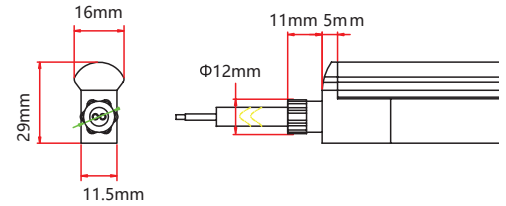

Seamless Side Exit

NA-11D-1-01-3W-SE-1-SR-XXX-S
NA-11D-1-01-3W-SE-2-SL-XXX-S

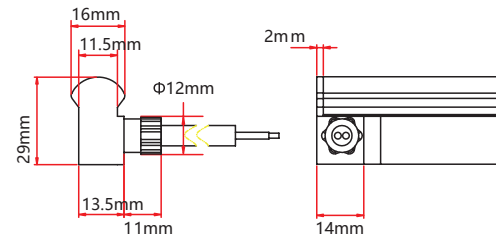

Seamless Bottom Exit

NA-11D-1-01-3W-SE-0-BO-XXX-S

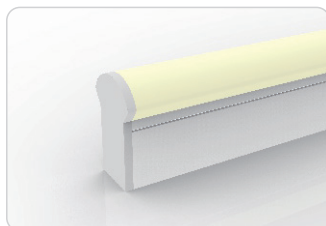
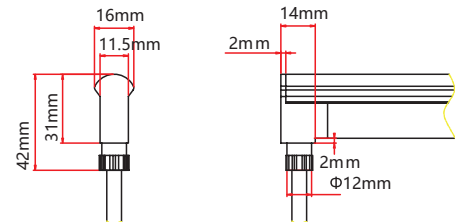

Seamless End Cap

NA-11D-1-01-0W-SE-1-EC-000-P
NA-11D-1-01-0W-SE-2-EC-000-P

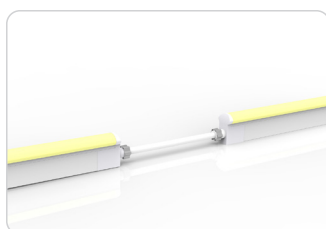
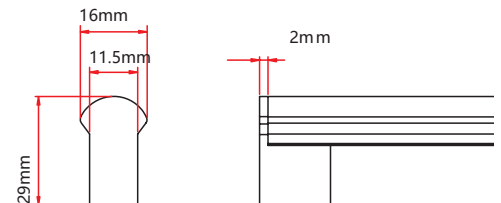

Seamless Jumper

NA-11D-1-01-3W-SE-0-EJ-XXX-S

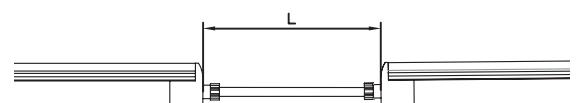

Connectors

IP68: Submersible. Waiting on 3rd party certification from UL as of 18/04/12. Factory Assembly only.

Submersible Seamless Connectors

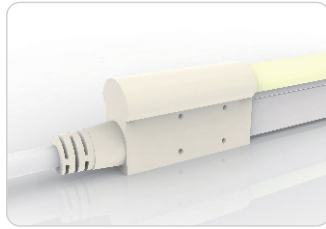

Submersible End Exit
NA-11D-1-01-3W-SU-0-EN-XXX-S

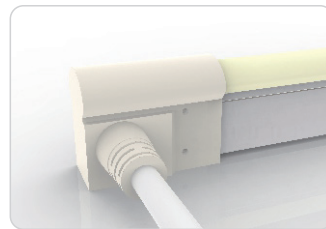
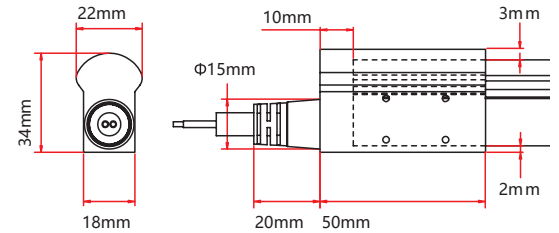

Submersible Side Exit
NA-11D-1-01-3W-SU-1-SR-XXX-S
NA-11D-1-01-3W-SU-2-SL-XXX-S

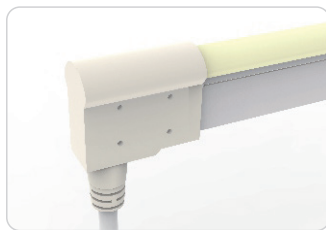
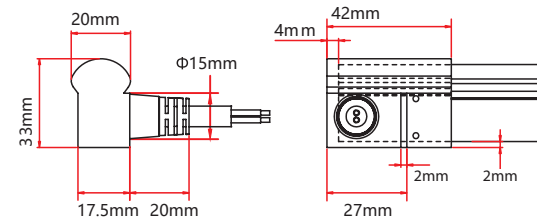

Submersible Bottom Exit
NA-11D-1-01-3W-SU-0-BO-XXX-S

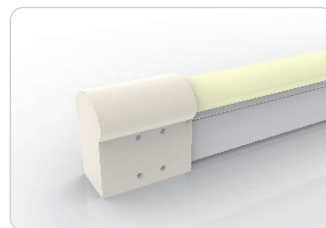
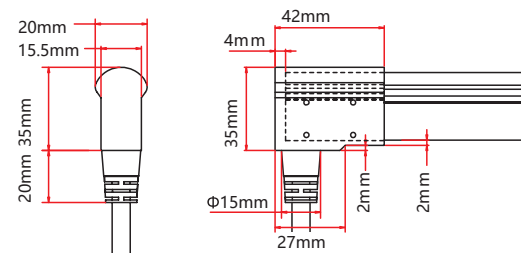

Submersible End Cap
NA-11D-1-01-0W-SU-1-EC-000-P
NA-11D-1-01-0W-SU-2-EC-000-P

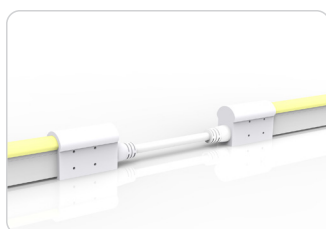
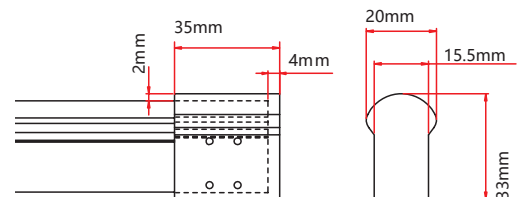

Submersible Jumper
NA-11D-1-01-3W-SU-0-EJ-XXX-S

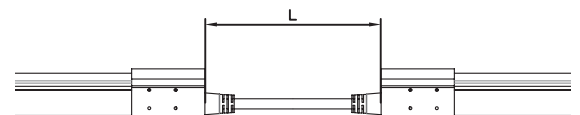

Connectors

Snap Connectors

IP67: Rated for outdoor use.
Factory Assembly or DIY.

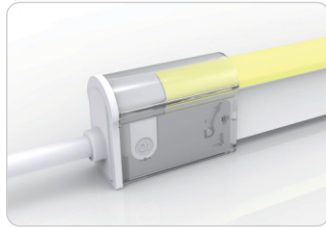

Snap End Exit

NA-11D-1-01-3W-SC-1-EN-XXX-S
NA-11D-1-01-3W-SC-2-EN-XXX-S

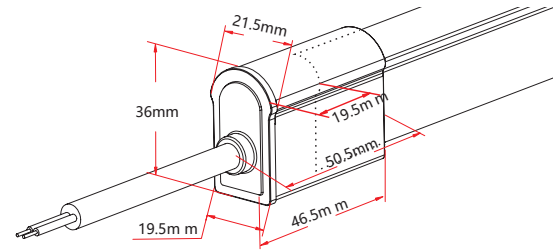

Snap Bottom Exit

NA-11D-1-01-3W-SC-1-BO-XXX-S
NA-11D-1-01-3W-SC-2-BO-XXX-S

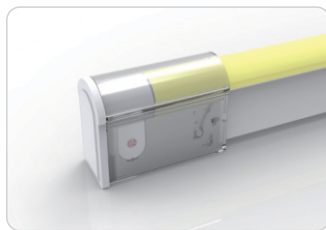
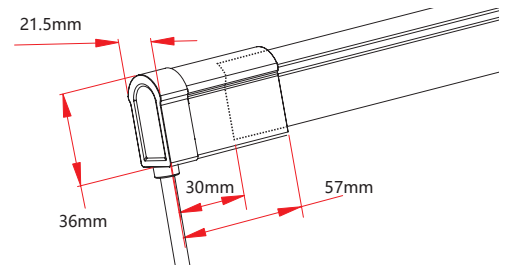

Snap End Cap

NA-11D-1-01-0W-SC-1-EC-000-P
NA-11D-1-01-0W-SC-2-EC-000-P

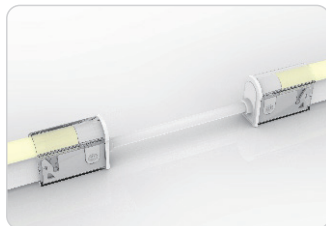
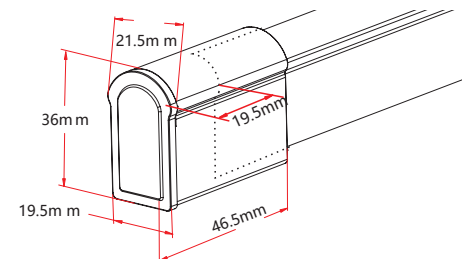

Snap Jumper

NA-11D-1-01-3W-SC-0-EJ-XXX-S

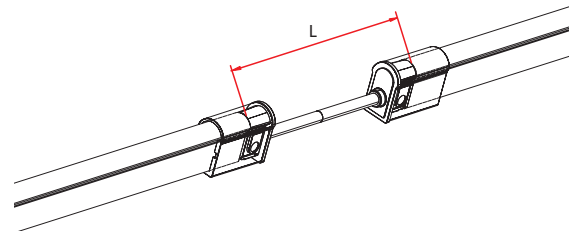

Snap Power T Feed

NA-11D-1-01-3W-SC-0-TF-XXX-S

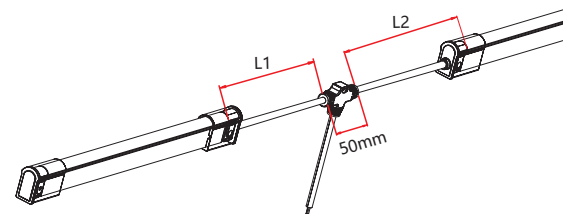

Connectors

IP20: Rated for indoor use only.
Factory Assembly only.

Barrel Connectors



Barrel Connectors

- NA-XX-BC-DC-CXX-F
- NA-XX-BC-DC-CXX-M
- NA-XX-BN-XXA-CXX-F
- NA-XX-BN-XXA-CXX-M
- NA-XX-PL-XXA-CXX-F
- NA-XX-PL-XXA-CXX-M

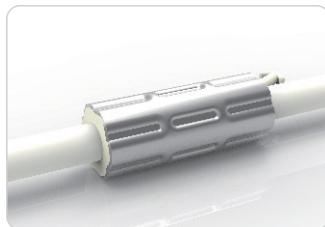
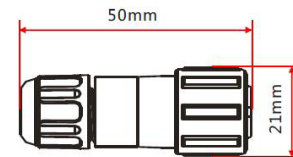

Anti-Wicking Ferrule

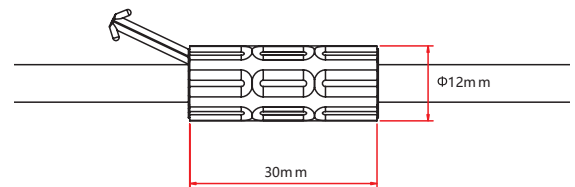

Anvil Cutter

Optional accessory for on-site cutting.

Factory order only

Mounting Hardware

Standard Anodized Aluminum Channel

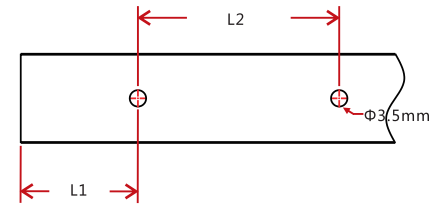
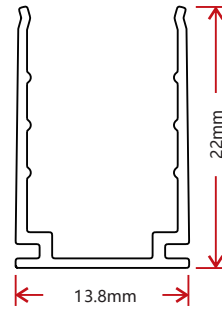
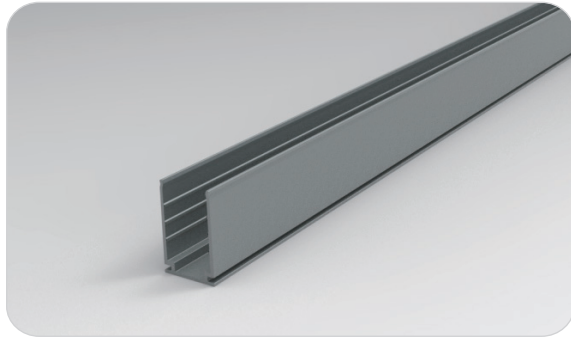

| W x H | Standard Length | Part Number | L1 | L2 | Screw Hole Φ | Hole # |
|--------------------------------|------------------|-------------------|-----------------|----------------|-----------------------|--------|
| 0.54 x 0.87in (13.8 x 22mm) | 1.38in (35mm) | CL-11-R-AL-3C5-SD | 0.69in (17.5mm) | / | Φ 0.14in (3.5mm) | 1 |
| | 19.69in (500mm) | CH-11-R-AL-0M5-SD | 1.97in (50mm) | 7.87in (200mm) | Φ 0.14in (3.5mm) | 3 |
| | 39.37in (1000mm) | CH-11-R-AL-01M-SD | 3.94in (100mm) | 7.87in (200mm) | Φ 0.14in (3.5mm) | 5 |
| | 78.74in (2000mm) | CH-11-R-AL-02M-SD | 3.94in (100mm) | 7.87in (200mm) | Φ 0.14in (3.5mm) | 10 |

Plastic Channel

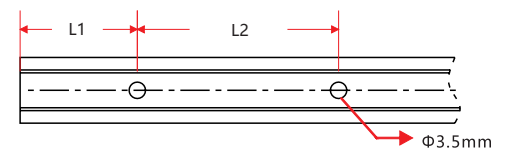
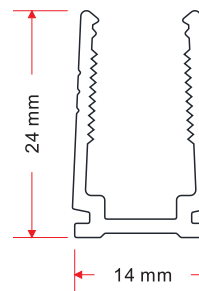

| W x H | Standard Length | Part Number | L1 | L2 | Screw Hole Φ | Hole # |
|------------------------------|------------------|-------------------|----------------|----------------|-----------------------|--------|
| 0.55 x 0.94in (14 x 24mm) | 19.69in (500mm) | CH-11-R-PL-0M5-SD | 1.97in (50mm) | 7.87in (200mm) | Φ 0.14in (3.5mm) | 3 |
| | 39.37in (1000mm) | CH-11-R-PL-01M-SD | 3.94in (100mm) | 7.87in (200mm) | Φ 0.14in (3.5mm) | 5 |
| | 78.74in (2000mm) | CH-11-R-PL-02M-SD | 3.94in (100mm) | 7.87in (200mm) | Φ 0.14in (3.5mm) | 10 |

Mounting Hardware

Spring Clip Anodized Aluminum Channel

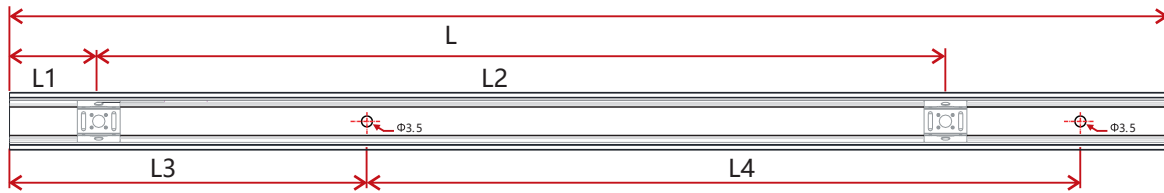
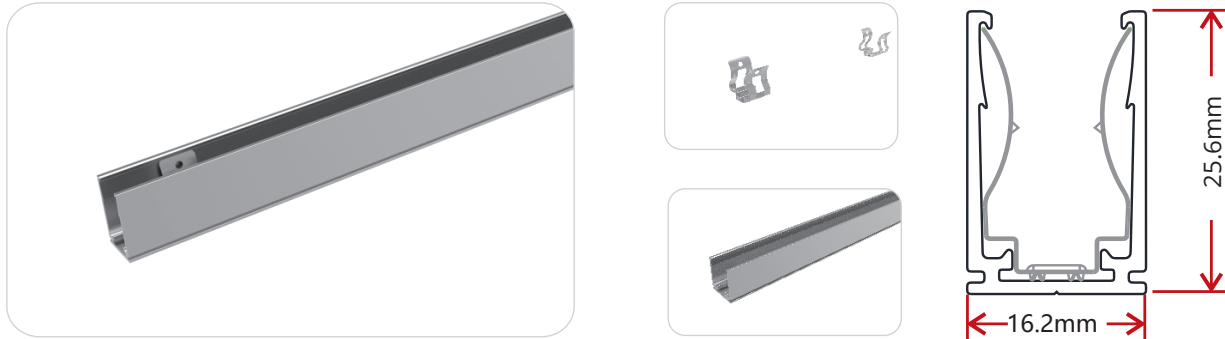

| W x H | Standard Length | Part Number | L1 | L2 | L3 | L4 | Screw Hole Φ | Hole # | Clip # |
|-----------------|------------------|-------------------|-----------------|------------------|----------------|----------------|-----------------------|--------|--------|
| 0.64 x 1.01in | 1.38in (35mm) | CL-11-R-AL-3C5-SP | 0.69in (17.5mm) | / | 0.2in (5mm) | 0.98in (25mm) | Φ 0.14in (3.5mm) | 2 | 1 |
| (16.2 x 25.6mm) | 19.69in (500mm) | CH-11-R-AL-0M5-SP | 0.98in (25mm) | 8.86in (225mm) | 1.97in (50mm) | 7.87in (200mm) | Φ 0.14in (3.5mm) | 3 | 3 |
| | 39.37in (1000mm) | CH-11-R-AL-01M-SP | 0.98in (25mm) | 9.35in (237.5mm) | 3.94in (100mm) | 7.87in (200mm) | Φ 0.14in (3.5mm) | 5 | 5 |
| | 78.74in (2000mm) | CH-11-R-AL-02M-SP | 0.98in (25mm) | 9.6in (243.8mm) | 3.94in (100mm) | 7.87in (200mm) | Φ 0.14in (3.5mm) | 10 | 9 |

Stainless Steel Flexible Channel

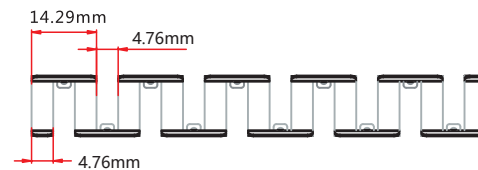
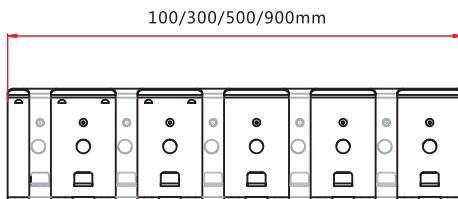
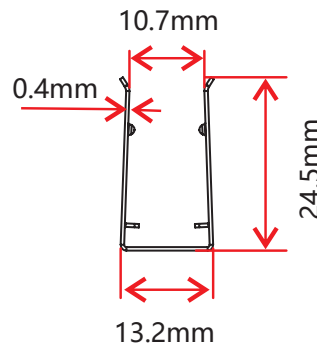

| W x H | Standard Length | Part Number |
|-----------------|-----------------|-------------------|
| 0.52 x 0.97in | 3.94in (100mm) | CH-11-F-SS-0M1-SD |
| (13.2 x 24.5mm) | 11.81in (300mm) | CH-11-F-SS-0M3-SD |
| | 19.69in (500mm) | CH-11-F-SS-0M5-SD |
| | 35.43in (900mm) | CH-11-F-SS-0M9-SD |

This profile can be mounted using screws in any gaps where the channel bends.

Packaging



White Box

Packing Box

| Fixture Length | White Box Dimensions | Packing Box Dimensions | # Of White Boxes | Package Weight |
|----------------|----------------------------------|----------------------------------|------------------|-----------------|
| 196.85in (5m) | 15.35x2.05x19.67in (39x5.2x50cm) | 20.47x16.14x11.02in (52x41x28cm) | 5 | 30.86lbs (14kg) |
| 393.7in (10m) | 20.08x2.05x24.41in (51x5.2x62cm) | 25.2x20.87x11.02in (64x53x28cm) | 5 | 57.32lbs (26kg) |
| 393.7in (10m) | 20.08x2.05x24.41in (51x5.2x62cm) | 25.2x20.87x6.9in (64x53x17.5cm) | 3 | 35.27lbs (16kg) |
| 787.4in (20m) | 26.77x2.05x31.1in (68x5.2x79cm) | 31.9x27.56x4.92in (81x70x12.5cm) | 2 | 48.5lbs (22kg) |

Testing

Photometric Data

W+WW

| | | |
|------------|-------------|---------|
| LED Type | SMD | |
| Beam Angle | 270 ° | |
| Color | Wavelength | Lumen/m |
| W | 2460 ± 120K | >130lm |
| WW | 5029 ± 283K | >130lm |
| W+WW | 3465 ± 245K | >260lm |

Testing

Certifications

| | Testing Organization | Certificate Serial N° | Report Reference |
|---------|----------------------|-----------------------|------------------|
| UL 2108 | UL | 20160726-E360029 | E360029-2013 |
| CE-EMC | SGS | SZEM1702001259LMV | SZEM160600421302 |

Fixture Testing

Optical Testing

| | |
|------------------------------|--|
| Spectrum Analysis | IES LM 79 (Lumen, CCT, CRI, XY, SDCM, wavelength) |
| Photometric Distribution | IES LM 73 (Lumen intensity distribution & Lux diagram) |
| Lumen Maintenance & Lifetime | IES LM 84 & IES TM28 |

Temperature Testing

| | |
|-------------------------|--|
| Normal Temperature Test | UL1598 & UL2388 & IEC60598-1 & IEC60598-2-21 |
| Abnormal Operation Test | UL1598 & UL2388 & IEC60598-1 & IEC60598-2-21 |

Durability Testing

| | |
|--------------|---|
| Bending Test | Manufacturer-defined, 500 cycles |
| Swing Test | UL2388, >750 cycles |
| Tensile Test | Manufacturer-defined, > the weight of light in max. connection length double feed |
| Twist Test | Max connection length double feed Manufacturer-defined, >200 cycles |
| Ball Impact | UL1598 & UL2388 & IEC60598-1 & IEC60598-2-21 |
| IK07 IK08 | IEC62262 |

Environmental Testing

| | |
|-----------------------------|--|
| Chlorinated Water Immersion | BG9667, PH6.8-7.6, free chlorine 0.3-0.6mg/L |
| Salt Water Immersion | IEC60598-1, Salinity 4% |
| Salt Spray Test | IEC68-2-11 |
| Outdoor Exposure | Manufacturer-defined |
| Flame Resistance | UL94 |
| UV Exposure | ASTMG 154, ISO 4892-3, UVA @ 340nm |
| IPX5, IPX6, IPX7, IPX8 | IEC60529 |
| Temperature Shock | Manufacturer-defined, -40°C - 60°C (typical temperature range) |
| Constant Temperature | Manufacturer-defined |

Testing

Charts

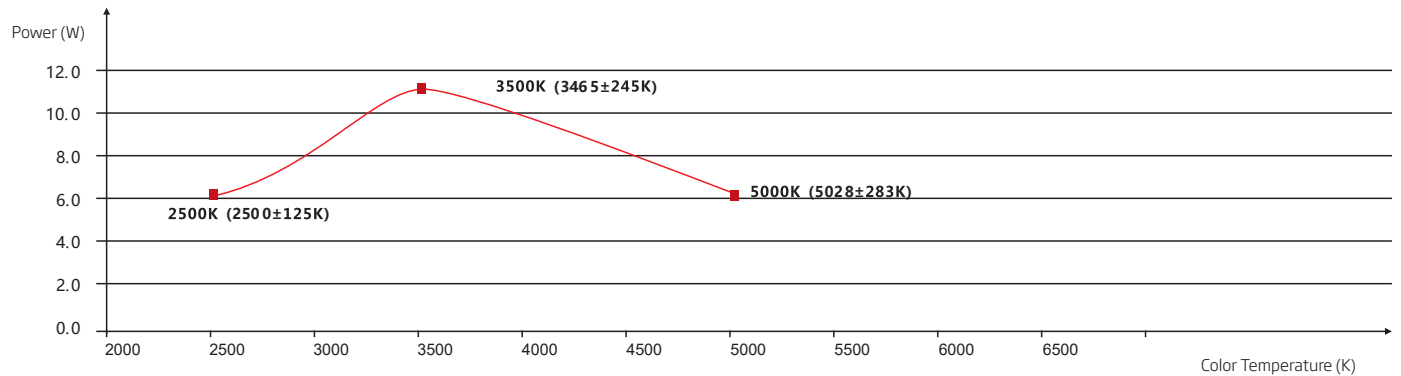

Power vs. CCT

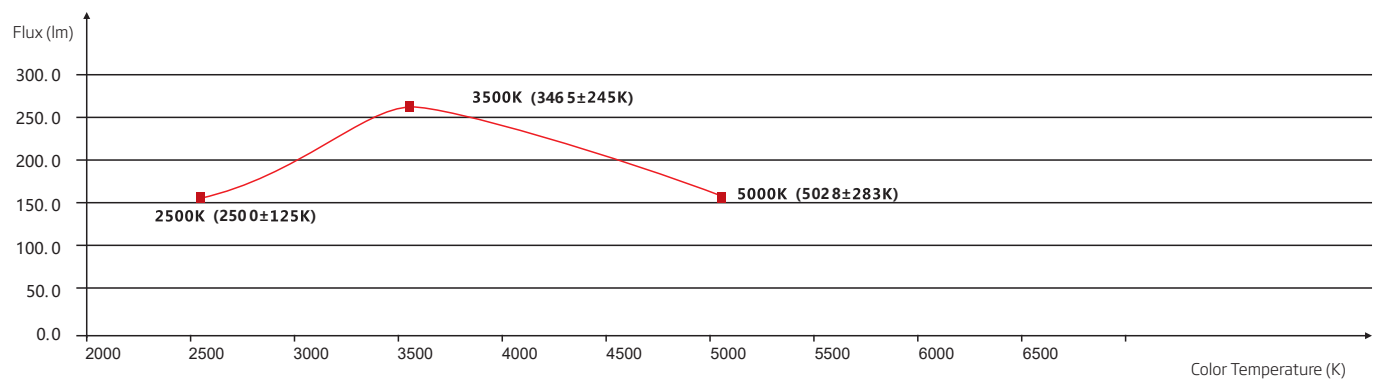

Luminous Flux vs. CCT

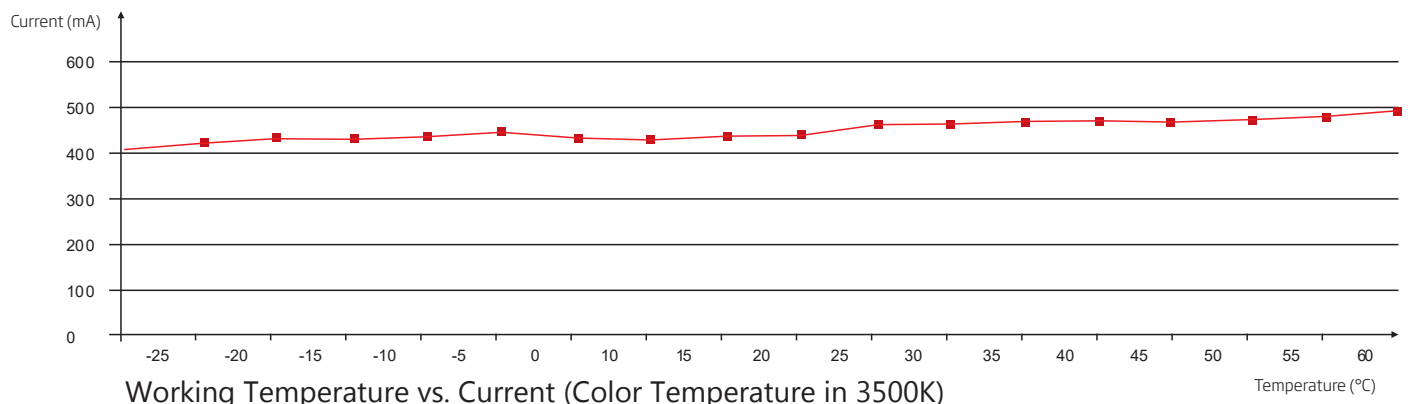

Working Temperature vs. Current (Color Temperature in 3500K)

Testing

Charts

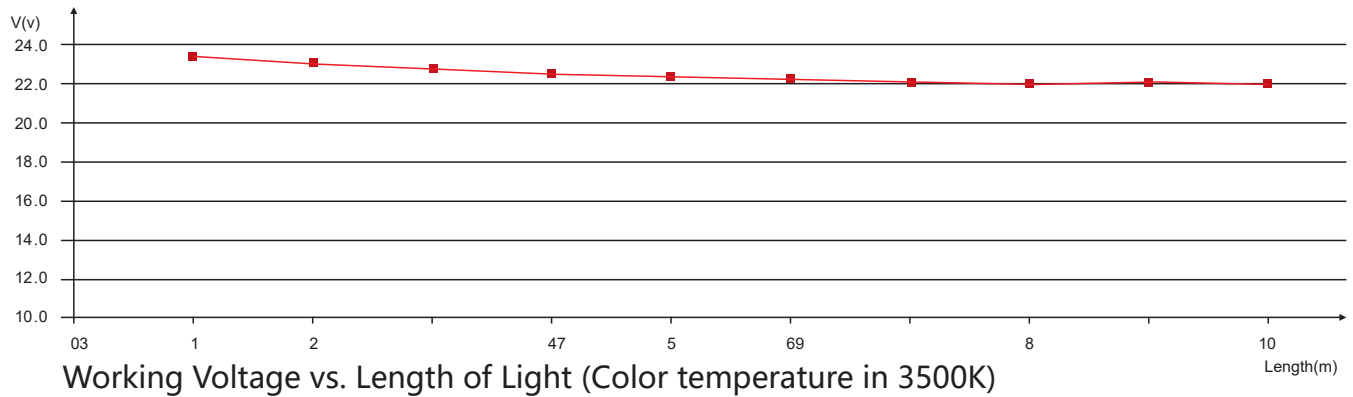

ANSI STANDARD

Nominal CCT Categories

| Nominal CCT | Target CCT and tolerance(K) | Target D_{uv} | D_{uv} Tolerance Range |
|---------------------------|------------------------------|-------------------|------------------------------------|
| 2200K | 2238 ±102 | 0.0000 | Tx:CCT of the source |
| 2500K | 2460±120 | 0.0000 | For Tx<2870K |
| 2700K | 2725 ±145 | 0.0000 | 0.000±0.0060 |
| 3000K | 3045±175 | 0.0001 | For Tx≥2870K |
| 3500K | 3465±245 | 0.0005 | $D_{uv}(Tx)±0.0060$ |
| 4000K | 3985±275 | 0.0010 | where |
| 4500K | 4503±243 | 0.0015 | $D_{uv}(Tx)=57700 \times (1/Tx)^2$ |
| 5000K | 5029±283 | 0.0020 | -44.6 x (1/Tx) |
| 5700K | 5667±355 | 0.0025 | +0.00854 |
| 6500K | 6532±510 | 0.0031 | |
| Flexible CCT (2200-6500K) | $T_f^{1)} \pm \Delta T^{2)}$ | $D_{uv} T_f^{3)}$ | |

Remark:

- 1) T_f is chosen to be at 100K steps (2300,2400,.....,6400K), excluding the ten nominal CCTs listed in Table 1.
- 2) $\Delta T = 1.1900 \times 10^8 \times T^3 - 1.5434 \times 10^4 \times T^2 + 0.7168 \times T - 902.55$
- 3) Same as in the D_{uv} Tolerance Range.

Loading Chart

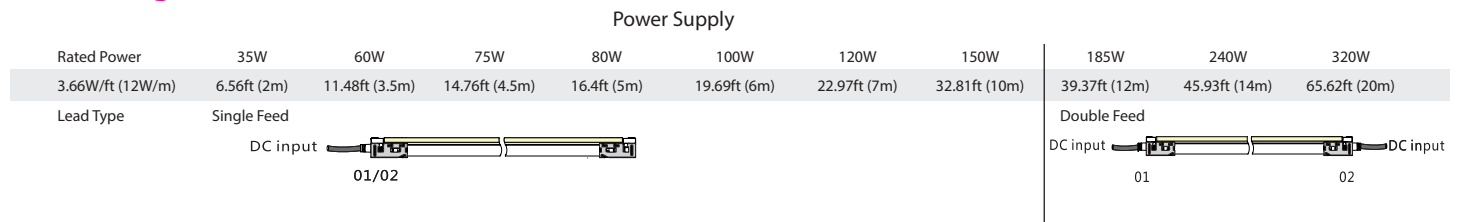

Note: These are the max recommended run lengths based on power supply

For example: It is recommended to use one 80W power supply for a single-fed run of 16.4ft (5m) at 3.66W/ft (12W/m).



Testing

Charts

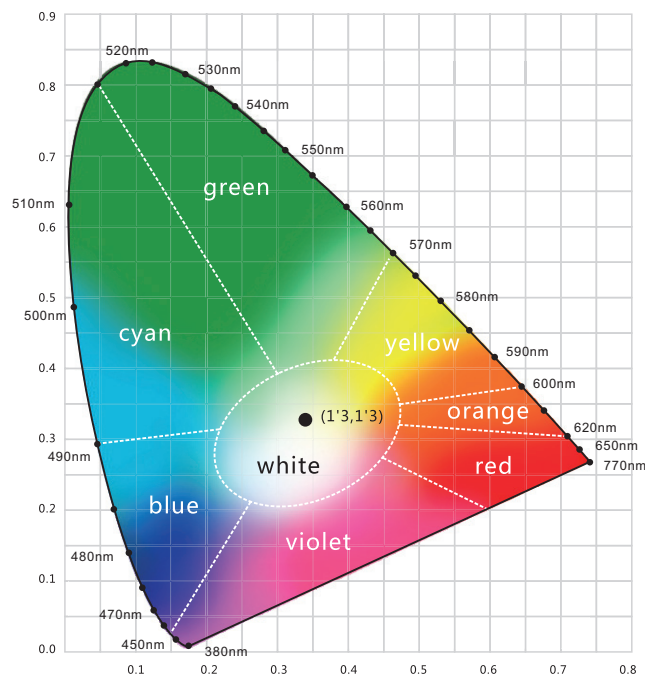
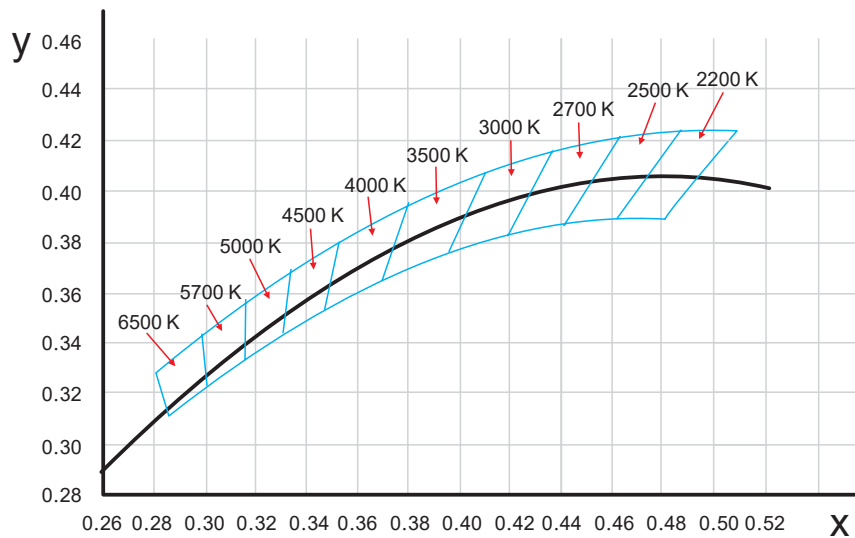
(X,Y) Chromaticity Diagram



Light Color

-  **Red**
620-630nm
-  **Green**
520-530nm
-  **Blue**
465-475nm